



86mm

(SIZE 34)

HB

TYPE

高トルク

High torque

1.8°

RoHS対応

RoHS compliant products.

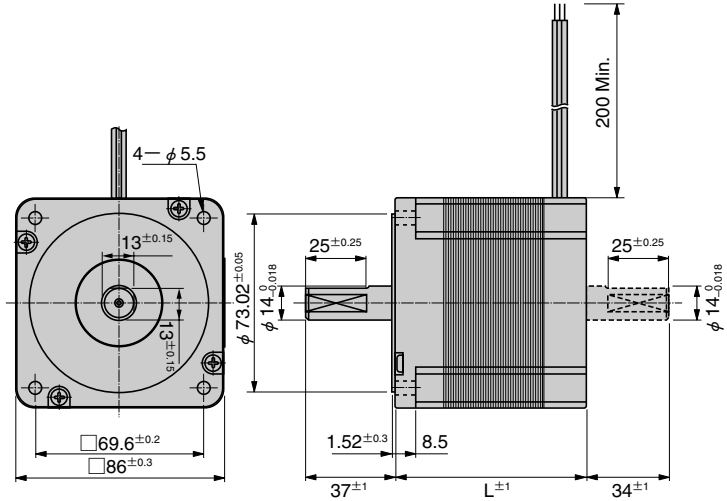
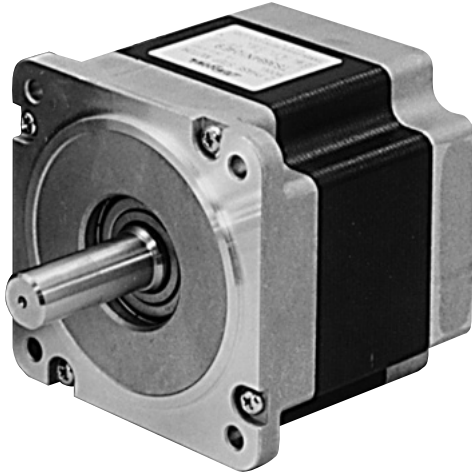

2相ステップモータ仕様

形式 Type number		ステップ角 Step Angle	結線 Winding Type	定格電圧 Rated Voltage	定格電流 Rated Current	巻線抵抗 Winding Resistance	インダクタンス Inductance	ホールディングトルク Holding Torque	モータ長L Motor Length	ロータイナーシャ Rotor Inertia	質量 Mass
片軸 Single Shaft	両軸 Dual Shaft	Deg.		V/Phase	A/Phase	Ω/Phase	mH/Phase	N·m(kgf·cm)	mm	x10 ⁻⁴ kg·m ²	kg
TS3684N1E3	TS3684N11E3	1.8	TYPE 1	1.8	4.5	0.4	1.75	2.5 (25)	79	1.6	2.5
		1.8	TYPE 2	1.28	6.4	0.2	1.75	3.5 (35)			
		1.8	TYPE 3	2.56	3.2	0.8	7	3.5 (35)			
TS3684N2E6	TS3684N12E6	1.8	TYPE 1	2.8	4.5	0.62	3.1	5.5 (55)	117.5	3.2	3.5
		1.8	TYPE 2	1.98	6.4	0.31	3.1	7.8 (78)			
		1.8	TYPE 3	3.97	3.2	1.24	12.4	7.8 (78)			
TS3684N3E8	TS3684N13E8	1.8	TYPE 1	3.36	4.0	0.84	4.7	7.5 (75)	156	4.8	5.0
		1.8	TYPE 2	2.39	5.7	0.42	4.7	10.6 (106)			
		1.8	TYPE 3	4.7	2.8	1.68	18.8	10.6 (106)			

- 使用周囲温度 ———— -20~+50°C
Operating temperature range
- 絶縁抵抗 ———— 100MΩ Min (at DC500V)
Insulation resistance
- 絶縁耐圧 ———— AC 500V (1min)
Dielectric strength
- スラストプレイ ———— 0.075mm Max. at the load
Thrust play
67N(6.8kgf)
- ラジアルプレイ ———— 0.025mm Max. at the load
Radial play
4.4N(0.45kgf)
- 許容温度上昇 ———— 80 deg Max. (Resistance method)
Permissible temperature rise

※ご注意：モータのケース表面温度は90℃以下でお使いください。
 ※NOTE: Do not allow the surface temperature of the motor case to rise above 90℃ during operation.

結線図 WIRING DIAGRAM

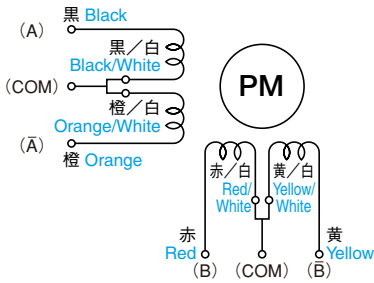

TYPE 1 ユニポーラ UNIPOLAR

回転方向
出力軸より見て CW 方向 CW rotation from output shaft end.

Step	黒 Black	赤 Red	橙 Orange	黄 Yellow	黒/白と橙/白を接続 Black/White connects with Orange/White	赤/白と黄/白を接続 Red/White connects with Yellow/White
0	ON	ON			COM	COM
1		ON	ON		COM	COM
2			ON	ON	COM	COM
3	ON			ON	COM	COM
4	ON	ON			COM	COM

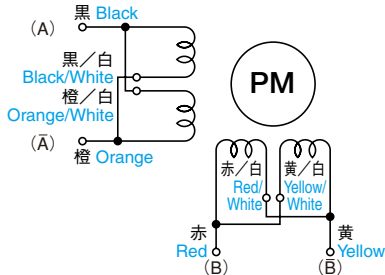

TYPE 2 バイポーラ(パラレル結線) BIPOLAR (Parallel connection)

黒/白と橙/白をA相COM. Phase A COM are Black/White and Orange/White
赤/白と黄/白をB相COM. Phase B COM are Red/White and Yellow/White

Step	黒 & 橙/白 Black&Orange/White	赤 & 黄/白 Red&Yellow/White	橙 & 黒/白 Orange&Black/White	黄 & 赤/白 Yellow&Red/White
0	+	+	-	-
1	-	+	+	-
2	-	-	+	+
3	+	-	-	+
4	+	+	-	-

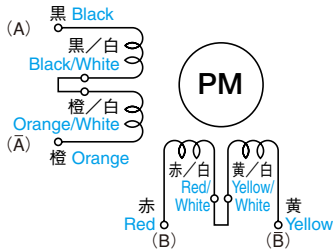

TYPE 3 バイポーラ(シリーズ結線) BIPOLAR SERIES (Series connection)

黒/白と橙/白を接続 Black/White connects with Orange/White
赤/白と黄/白を接続 Red/White connects with Yellow/White

Step	黒 Black	赤 Red	橙 Orange	黄 Yellow
0	+	+	-	-
1	-	+	+	-
2	-	-	+	+
3	+	-	-	+
4	+	+	-	-

パルスレートトルク特性 (プルアウトトルク) PULSE RATE VS TORQUE CHARACTERISTICS (Pull-out Torque)

TS3684N1E3 (TYPE2)

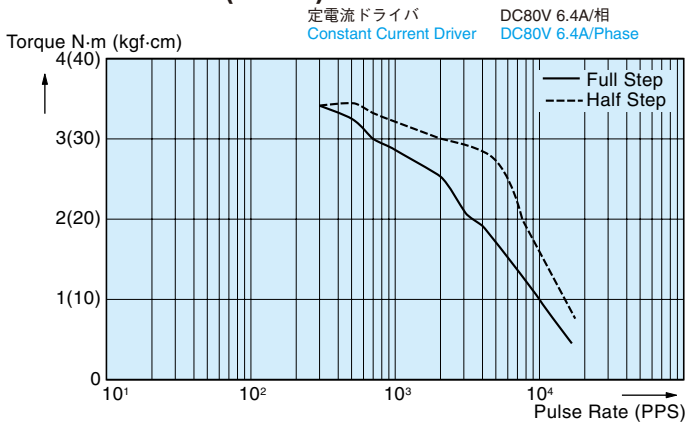

TS3684N2E6 (TYPE2)

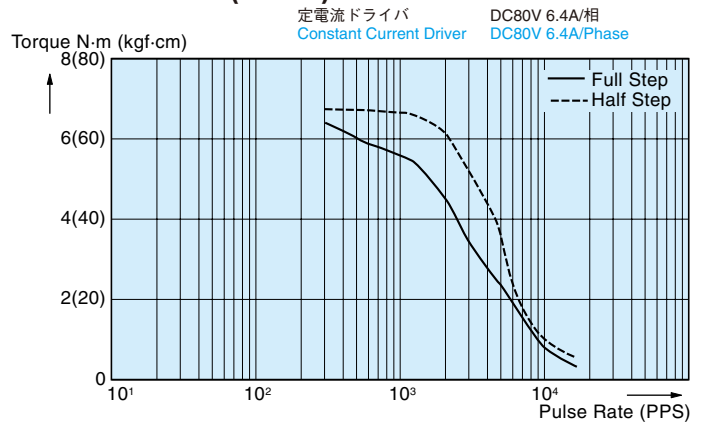

TS3684N3E8 (TYPE2)

